



COMANSA

LCL

LCL-250

26,450 lbs.

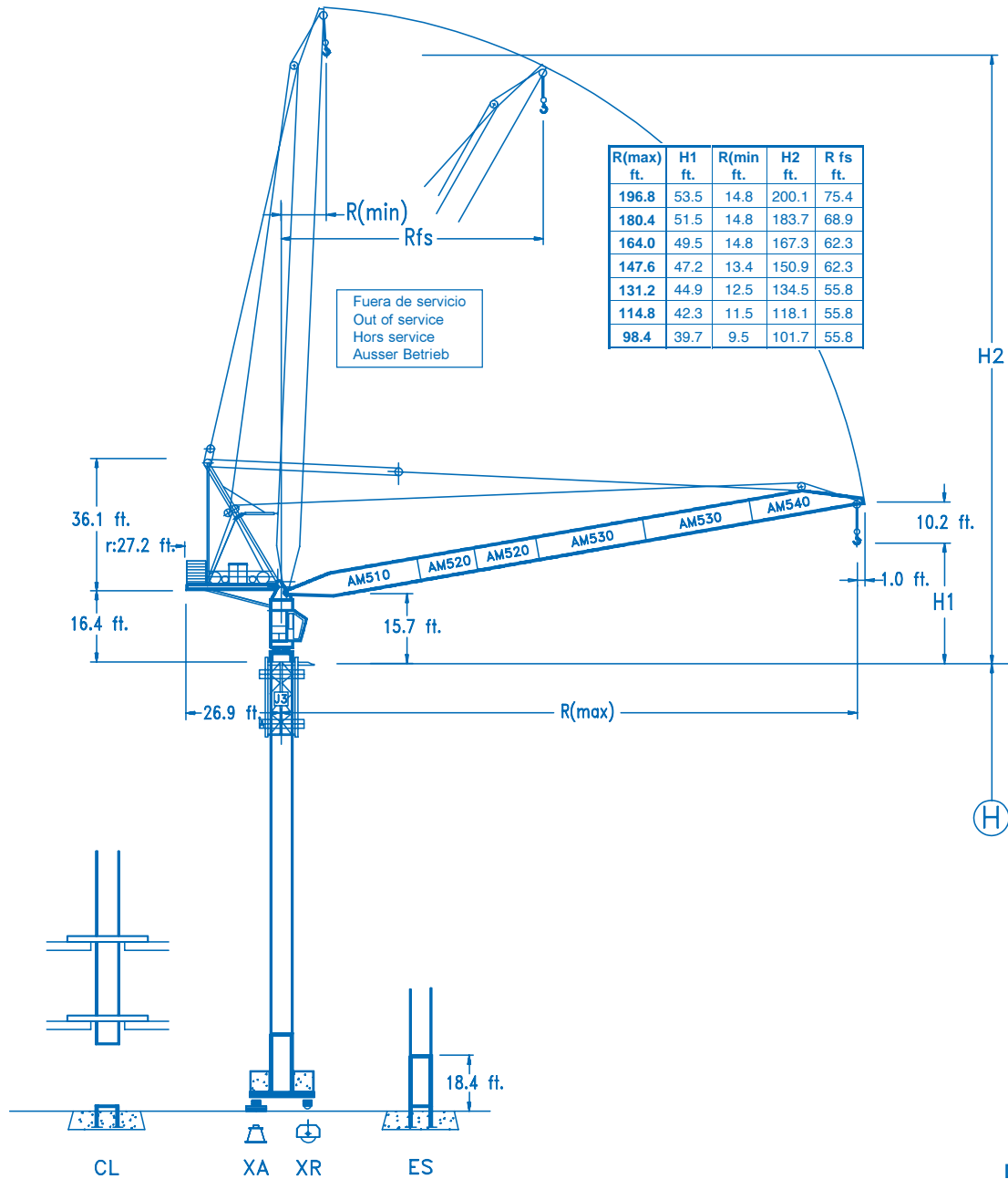

R	⚙️				⚙️											
196.8	73.1	82.0	88.6	98.4	108.6	114.8	121.4	131.2	137.8	147.6	154.2	164.0	170.6	180.4	196.8	ft.
26,450	21,840	18,980	16,110	13,220	12,120	11,150	9,960	9,260	8,370	7,870	7,230	6,410	5,860	5,070	lbs.	
180.4	75.4	82.0	88.6	98.4	105.0	115.8	121.4	131.2	137.8	147.6	154.2	164.0	170.6	180.4	ft.	
26,450	23,320	20,800	17,540	16,000	13,220	12,390	11,110	10,380	9,410	8,860	8,090	7,620	6,610	lbs.		
164.0	75.4	82.0	88.6	98.4	105.0	114.8	121.4	130.5	137.8	147.6	154.2	164.0	ft.			
26,450	24,000	21,950	19,090	17,720	15,980	14,960	13,220	12,230	11,280	10,710	9,920	lbs.				
147.6	75.4	82.0	88.6	98.4	105.0	114.8	121.4	131.2	140.7	147.6	ft.					
26,450	24,350	22,550	20,300	18,690	17,060	16,130	14,920	13,220	12,560	lbs.						
131.2	75.4	82.0	88.6	98.4	105.0	114.8	121.4	131.2	ft.							
26,450	24,440	22,740	20,560	19,000	17,450	16,570	15,430	lbs.								
114.8	77.1	82.0	88.6	98.4	105.0	114.8	ft.									
26,450	25,010	23,360	21,250	19,720	18,290	lbs.										
98.4	78.7	82.0	88.6	98.4	ft.											
26,450	25,350	23,380	20,940	lbs.												

(H)	(R)
ft.	ft.
168.6	98.4
150.5	114.8/131.2
132.5	147.6/164.0
114.5	180.4/196.8

(H)	(R)
ft.	ft.
180.7	98.4
162.7	131.2
144.6	164.0
126.6	196.8
108.6	196.8

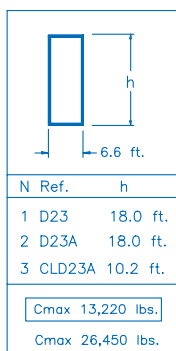
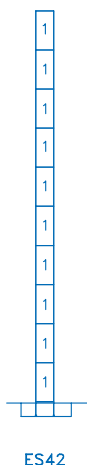
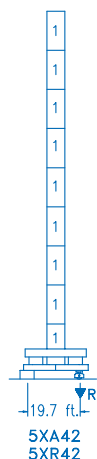

VER./CL

(H)	(R)
ft.	ft.
154.8	98.4/131.2/164.0
136.8	114.8
118.7	196.8

	H [ft.]	P [lbs.]	T [lbs.]
(1)	154.8	226,570	38,130
(2)	138.8	219,300	37,910
(3)	118.7	212,020	35,920

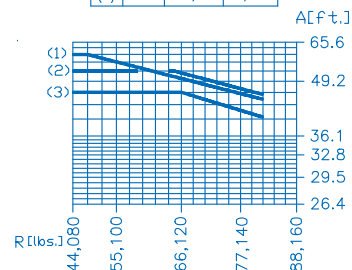
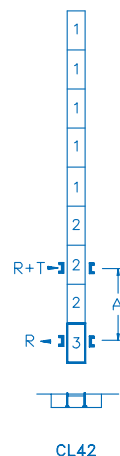

R. máx. En servicio
In operation
En service
In Betrieb

5XR42 262,280 lbs.

R. máx. Fuera de servicio
Out of service
Hors service
Ausser Betrieb

5XR42 341,400 lbs.

AFU-60

80 hp.

2 min

GR-10

3 x 74 Nm

0 ⇄ 0,8 rpm

TRA-7.5

2 x 55 Nm

0 ⇄ 78 ft./min

TRA-7.5VC

2 x 55 Nm

0 ⇄ 78 ft./min

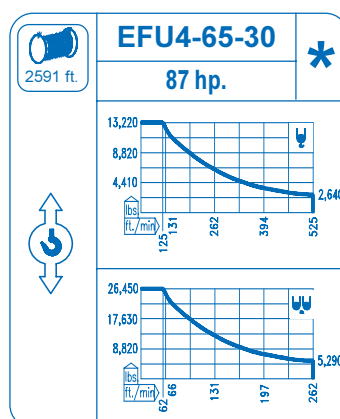
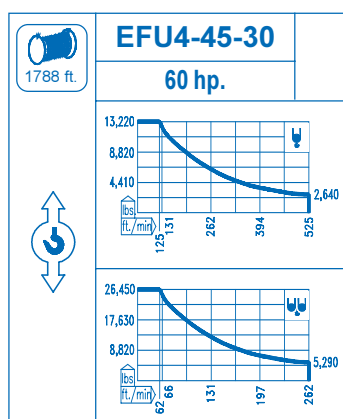

Tensión de alimentación
Operating voltage
Tension de service
Betriebsspannung

480 V
3 ph
60 Hz

Opcional
Optional
En option
Kaufoption
